

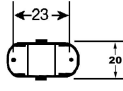

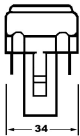

LAMPES TECHNIQUES



OLYMPUS	LAVE - ENDOSCOPE
	UV K-14L (5000 h)
	
	<i>WEDECO KATADYN</i>
Référence	683245*

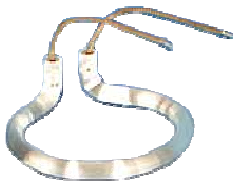

LAMPE GERMICIDE	  G23	
		<i>TUV-PL-S</i>
Référence	211012*	
Culot	G23	
Watts	11W	

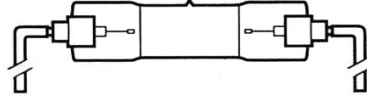
LAMPES INFRA-ROUGES	 dorée		
	Référence	664635	627066
Culot	GZ6,35	E27	E27
Volts	15V	220V	220V
Watts	150W	250W	100W
Heures	50	5000	5000
<i>Equivalence</i>	<i>OSR 64635</i>	<i>IR250R</i>	<i>IR100S</i>

CIRCLINE THERMO-QUARTZ	
Référence	1001
Culot Watts	Circline seul 400W

LAMPE U.V.	
Référence	ASH250*
	R7s câblé

CHAMBRES NOIRES		
	Rouge	Rouge
Référence	653870	653871
Culot	B22d	E27
Volts	230V	230V
Watts	15W	15W
Heures	1000	1000

BALANCE METTLER		
Référence	684301	691889
Culot	Ba15s	Ba15s
Volts	3V	6V
Ampère	1,5A	1,4A
Heures	500	1500

SPOT DE LECTURE	 10°
Référence	193076
Culot	E27
Volts-	230V
Watts	75W
Heures	2000
Equivalence	SP5 / SP6

*Soumis à Eco-contribution